



TUB AND SHOWER FAUCET TRIM

■ Leland® Bath Series

FEATURES:

- Monitor® 14 Series pressure balanced bath mixing valve.
- Touch-Clean® Showerhead
- MultiChoice® Universal rough valve body. (R10000 Series)
- H₂Okinetic Technology®

STANDARD SPECIFICATIONS:

- Maximum 2.0 gpm @ 80 psi, 7.6L/min @ 552 kPa
- Maximum 1.5 gpm @ 80 psi, 5.7L/min @ 552 kPa for models designated with H₂Okinetic Technology®
- Maintains a balanced pressure of hot and cold water even when a valve is turned on or off elsewhere in the system
- Back-to-back installation capability
- Solid brass forged body
- Temperature only controlled with handle
- Field adjustable to limit handle rotation into hot water zone
- 120° maximum handle rotation
- All parts replaceable from the front of the valve
- LHP - less handle program - see recommended handles below
- Stem extension kit RP77991 can be ordered to allow for an additional 1 3/4" wall thickness. RP77991 ships with chrome escutcheon screws. For special finishes also order RP12630 escutcheon screws in desired finish
- **Note:** Product will be marked with flow rate of specific showerhead.

WARRANTY

- Lifetime limited warranty on parts (other than electronic parts and batteries) and finishes: or, for commercial users, for 5 years from date of purchase.
- 5 year limited warranty on electronic parts (other than batteries); or, for commercial users, for 1 year from the date of purchase. No warranty is provided on batteries.



COMPLIES WITH:

- ASME A112.18.1 / CSA B125.1
- ASSE 1016
- EPA WaterSense®

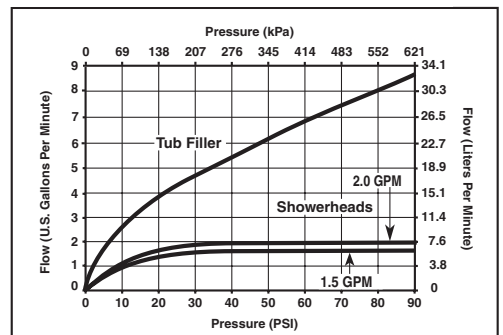

55 E. 111th Street, Indianapolis, Indiana 46280
 350 South Edgewise Road, St. Thomas, ON N5P 4L1
 © 2015 Masco Corporation of Indiana

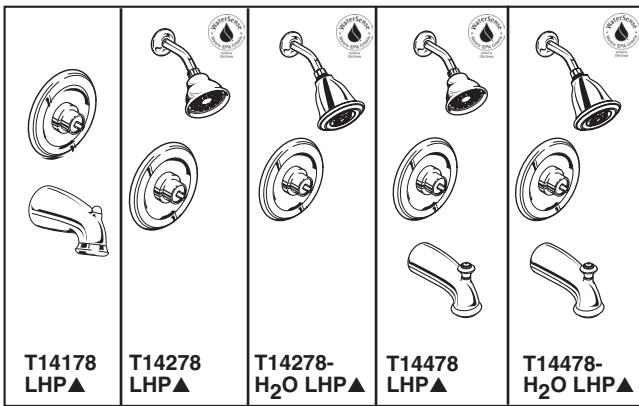

Submitted Model No.: _____

Specific Features: _____

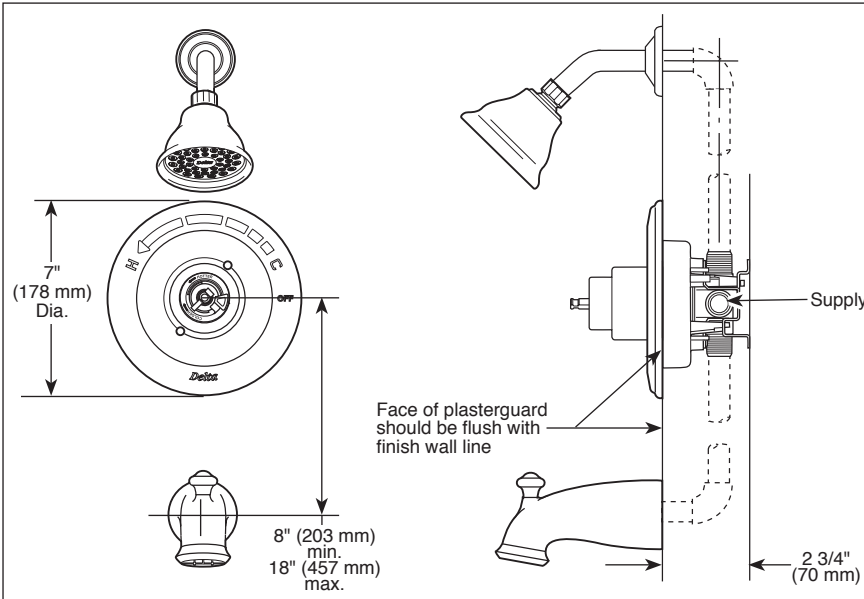

RP42915▲ (Pull-Up Diverter)

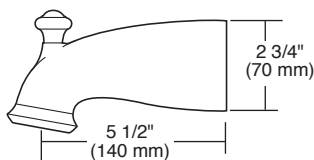

RP43165▲ (Non-Diverter)

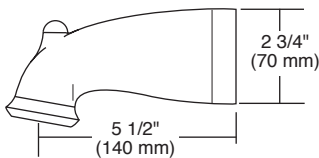

H777▲

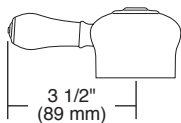

H778▲

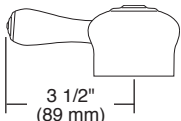

RP41589▲ Touch-Clean® Showerhead
2.0 GPM

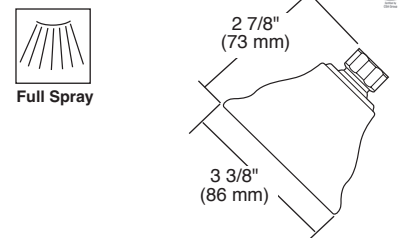

RP54752▲ H₂O Showerhead
1.5 GPM

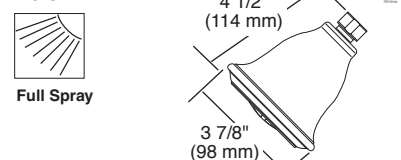

RP77991 Extension Kit

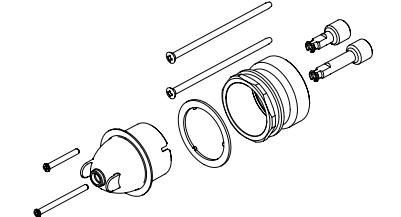

▲ Designate proper finish suffix

Delta reserves the right (1) to make changes in specifications and materials, and (2) to change or discontinue models, both without notice or obligation. Dimensions are for reference only. See current full-line price book or www.deltafaucet.com for finish options and product availability.